





# RATEAU

## TS0-S / TS1-S / TS2-S / TS3-S

Accessoire destiné aux petits travaux de finitions paysagers : réglage, tri des matériaux au sol...

CARACTÉRISTIQUES TECHNIQUES MACHINE				
MODULE	0	1	2	3
POIDS MACHINE MINI-MAXI	0,5 t – 2 t	2 t – 3,5 t	3,5 t – 5,5 t	5,5 t – 7,5 t
EFFORT DE CAVAGE MAXI	19 kN	28 kN	38,5 kN	56 kN
COUPLE MAXI	10 mkN	21 mkN	35 mkN	56 mkN

### CARACTÉRISTIQUES TECHNIQUES

	TS0-S	TS1-S	TS2-S	TS3-S
<b>LARGEUR</b>	1 200 mm	1 200 mm	1 400 mm	1 200 mm
<b>PAS</b>	60 mm	60 mm	114 mm	120 mm
<b>POIDS</b>	50 kg	83 kg	81 kg	143 kg

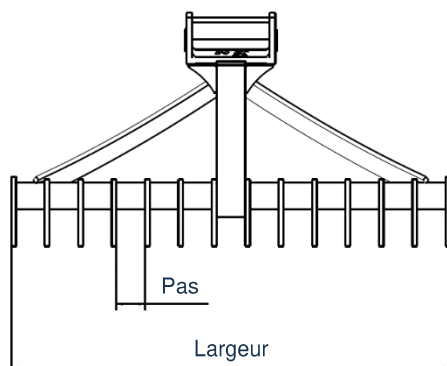
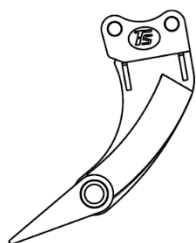





Le produit représenté est un exemple de produit générique. Il peut varier en fonction de la demande du client. Les caractéristiques techniques peuvent évoluer en fonction de la configuration de l'équipement du godet. Ce document ne peut être copié, ni reproduit, ni transmis sous aucune autre forme à une tierce personne sans autorisation préalable écrite d'ACTEYS.

# RAKE

## TS0-S / TS1-S / TS2-S / TS3-S

The RAKE is used for little ending landscaping works like fill spreading, filtering...

MACHINE TECHNICAL DATA				
MODULE	0	1	2	3
MACHINE WEIGHT RANGE	0,5 t – 2 t	2 t – 3,5 t	3,5 t – 5,5 t	5,5 t – 7,5 t
BREAK OUT FORCE	19 kN	28 kN	38,5 kN	56 kN
MAX. EXCAVATING TORQUE	10 mkN	21 mkN	35 mkN	56 mkN

### TECHNICAL DATA

	TS0-S	TS1-S	TS2-S	TS3-S
<b>WIDTH</b>	1 200 mm	1 200 mm	1 400 mm	1 200 mm
<b>GAP</b>	60 mm	60 mm	114 mm	120 mm
<b>WEIGHT</b>	50 kg	83 kg	81 kg	143 kg

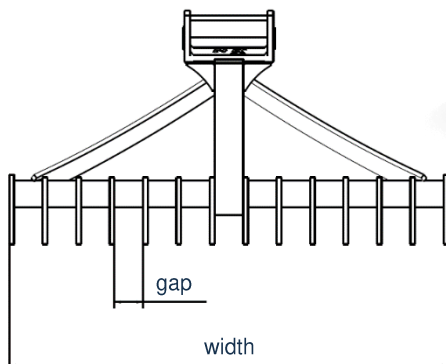
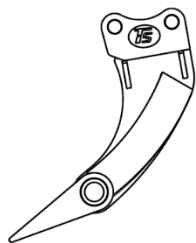





The displayed product is a generic product. It may be customized to meet the customer's requests. The technical data may evolve with the specifications and the bucket features. No part of this document may be copied, or reproduced, or transmitted in any forms or any means to other third person, without the prior written allowance of ACTEYS.

# RATEAU

## TS0-S / TS1-S / TS2-S / TS3-S

Accessoire destiné aux petits travaux de finitions paysagers : réglage, tri des matériaux au sol...

CARACTÉRISTIQUES TECHNIQUES MACHINE				
MODULE	0	1	2	3
POIDS MACHINE MINI-MAXI	0,5 t – 2 t	2 t – 3,5 t	3,5 t – 5,5 t	5,5 t – 7,5 t
EFFORT DE CAVAGE MAXI	19 kN	28 kN	38,5 kN	56 kN
COUPLE MAXI	10 mkN	21 mkN	35 mkN	56 mkN

### CARACTÉRISTIQUES TECHNIQUES

	TS0-S	TS1-S	TS2-S	TS3-S
<b>LARGEUR</b>	47 po	47 po	55 po	47 po
<b>PAS</b>	2,4 po	2,4 po	4,5 po	4,7 po
<b>POIDS</b>	110 lb	183 lb	178 lb	315 lb

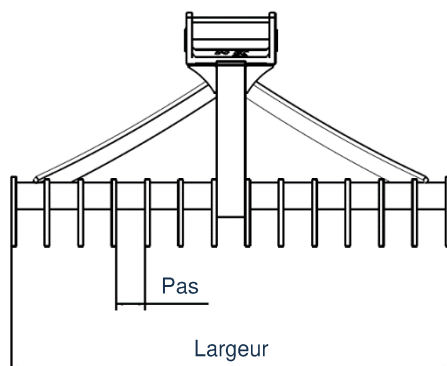
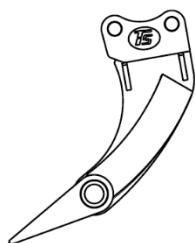





Le produit représenté est un exemple de produit générique. Il peut varier en fonction de la demande du client. Les caractéristiques techniques peuvent évoluer en fonction de la configuration de l'équipement du godet. Ce document ne peut être copié, ni reproduit, ni transmis sous aucune autre forme à une tierce personne sans autorisation préalable écrite d'ACTEYS.

# RAKE

## TS0-S / TS1-S / TS2-S / TS3-S

The RAKE is used for little ending landscaping works like fill spreading, filtering...

MACHINE TECHNICAL DATA				
MODULE	0	1	2	3
MACHINE WEIGHT RANGE	0,5 t – 2 t	2 t – 3,5 t	3,5 t – 5,5 t	5,5 t – 7,5 t
BREAK OUT FORCE	19 kN	28 kN	38,5 kN	56 kN
MAX. EXCAVATING TORQUE	10 mkN	21 mkN	35 mkN	56 mkN

### TECHNICAL DATA

	TS0-S	TS1-S	TS2-S	TS3-S
<b>WIDTH</b>	47 inches	47 inches	55 inches	47 inches
<b>GAP</b>	2,4 inches	2,4 inches	4,5 inches	4,7 inches
<b>WEIGHT</b>	110 lb	183 lb	178 lb	315 lb

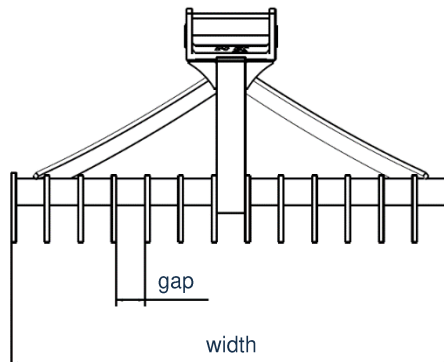
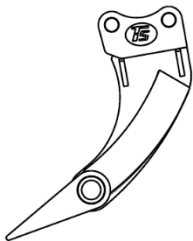





The displayed product is a generic product. It may be customized to meet the customer's requests. The technical data may evolve with the specifications and the bucket features. No part of this document may be copied, or reproduced, or transmitted in any forms or any means to other third person, without the prior written allowance of ACTEYS.



# RODERECHEN

## TS0-S / TS1-S / TS2-S / TS3-S

Der **RODERECHEN** ist hilfreich für kleine Landshcftsbauarbeiten wie Strahlstreuung, Sortierung...

TECHNISCHE DATEN DER MASCHINE				
MODUL	0	1	2	3
GEWICHT DER MASCHINE: MIN-MAX	0,5 t – 2 t	2 t – 3,5 t	3,5 t – 5,5 t	5,5 t – 7,5 t
LOSBRECHKRAFT	19 kN	28 kN	38,5 kN	56 kN
MAXIMALES AUSBRECHMOMENT	10 mkN	21 mkN	35 mkN	56 mkN

### TECHNISCHE DATEN

TS0-S    TS1-S    TS2-S    TS3-S

<b>BREITE</b>	1 200 mm	1 200 mm	1 400 mm	1 200 mm
<b>ABSTAND</b>	60 mm	60 mm	114 mm	120 mm
<b>GEWICHT</b>	50 kg	83 kg	81 kg	143 kg

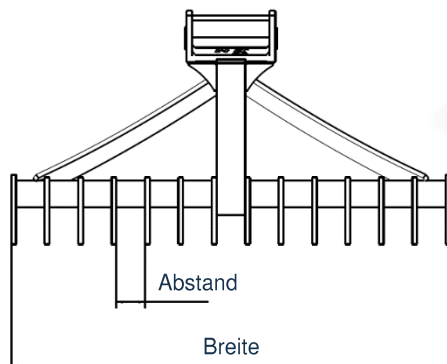
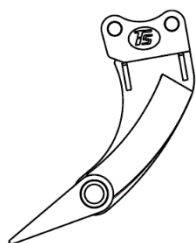

Das dargestellte Produkt ist ein generisches Produkt. Diese Produkt kann nach Kundenwunsch angepasst werden. Die technische Daten können je nach Ausstattung verändern werden. Dieses Dokument oder Teil aus diesem Dokument darf in irgend einer Form kopiert, reproduziert, oder eines Dritts übermittelt werden, ohne schriftliche Genehmigung von ACTEYS.

